

SMARTair® *i-max*

Euro profile

Update on Card

MAUER
ASSA ABLOY













SMARTAIR®
Your Access. Your Control.

Experience a safer
and more open world

A renewed electronic escutcheon with higher robustness passing the EN1906 Category of use Grade 4 standard. Including a new design of the reader with a sophisticated warning LED. *i-max* keeps all security components on the internal side of the door. It is suitable for all type of doors equipped with traditional mortise locks and it offers special solutions for glass doors and emergency exit doors. Easy installation without any wiring. Making it the perfect solution for offices, classrooms, meeting rooms, laboratories, etc. Avoiding mechanical keys and getting full access control functionality.



Technical data - SMARTair® *i-max*

	Door profiles	Suitable for wooden, narrow or glass doors
	Traffic volume	Medium to high
	Exterior usage	IP56 (Extreme version) Up to 85% humidity -20°C to +70°C
	Hardware compatibility and installation	High retrofit (compatible with most common mortise locks) Drilling, no cabling Doors from 30mm up to 120mm (thicker doors may be possible on demand)
	Power supply	Battery (from 75.000 to 105.000 cycles)* max. 2 years standby** Type of batteries: 3 LR03 AAA 1.5V alkaline batteries
	Multi-authentication	Yes (Card + PIN, PIN only, Card only)
	Status information	Handle usage Internal thumb-turn use recorded (only in models with electronic privacy) Mechanical opening recorded (in combination with a special mortise lock)
	Certifications	CE (EMC, R&TTE) ROHS, REACH, WEE, EN1634 (Fire) EN1906 Category of use Grade 4
	RFID technologies	HID iCLASS® MIFARE Classic and Ultralight SKIDATA DESFire
	Compatible mobile solutions	 Openow (Bluetooth Low Energy)
	System management upgradability	SMARTair® escutcheons can be upgradeable from Standalone > Offline / Update on Card > Wireless Online by: · Adding RF module · Firmware upgrade · Change of internal cover (plastic top)

* Depending on reading technology (MIFARE, iCLASS etc.):

** Depending on cycles per day.

Electronic Technical Characteristics

SMARTair *i-max* has the reader module on the external escutcheon and the control and battery module on the internal escutcheon. For Openow mobile solution, the models that include the BLE module must be ordered.

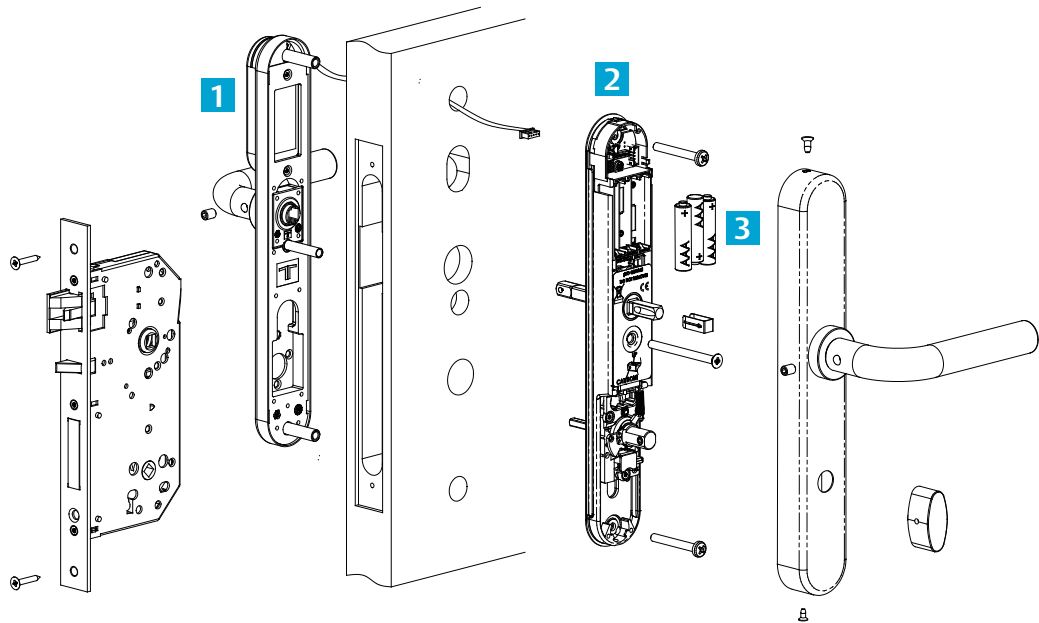

1 Reader Module

- 13,56MHz RFID Technology. Just changing the firmware the electronic escutcheon will work with one of the available reading technologies: MIFARE Classic (or Ultralight), HID iCLASS or DESFire.
- Activation mode. The electronic escutcheon will wake up just by approaching the credential. Without the need to make any previous action.
- Reading distance. 2-4cm. Given by the identification technology.
- Warning LED. Blue or red lights for different warning actions: granted access, access denied, low battery level, etc.
- Connection to the programming device. Through a special cable with three pins. Necessary to initialize the escutcheon and to make emergency openings (in case of low battery level and when there is not mechanical key override).

2 Control unit and battery module

- Non-volatile memory.
- Up to 3.000 users and 1.200 events.
- Real time clock and calendar. Up to 30 time zones with five different periods during the day. Weekdays and weekends automatically recognized. 365 days calendar to define holidays. DST's automatically updated through the calendar.
- Battery module. Easy battery change. Maintains clock and calendar for 5 minutes without batteries. The battery status reported on every event or once per day if no events happen.

Operation modes

Possibility to create state tables in the software, to define automatic changes in the doors (during the day) of the following operation modes:

- Passage mode: The door is open. This operation mode can be established automatically or manually by authorized users.

- First user: The door is closed until the first user with authorized access opens the door. After that operation, the door will remain in passage mode (open).
- Standard: The door is closed and a user with authorized access must approach its credential to open the door.
- Double user: The door is closed and two users with authorized access must approach their credentials to open the door.
- In models with keypad also: Keypad only: the users will enter a door code in the keypad to open the door. Card + PIN: the users must approach the card and after enter their PIN into the keypad to open the door. PIN + Card: the users must enter their PIN into the keypad and after approach their card to open the door.

Special features

- Standard or ADA users. Standard opening time from one to 15 seconds. ADDA users will have double time.
- High traffic doors: for unlimited number of users.
- Electronic privacy with internal thumb turn (to deny access to open the door when a user is inside and has activate the electronic privacy).
 - Privacy overrides passage (optional)
- Mechanical key override detection (with a special mortise lock)

3 Mobile solutions (Openow)

For mobile solutions, the electronic escutcheon MUST include the following RF module:

- Openow module. For offline and update on card systems.
- It is also necessary to activate the functionality in the software license.

The internal cover is metallic plus plastic.

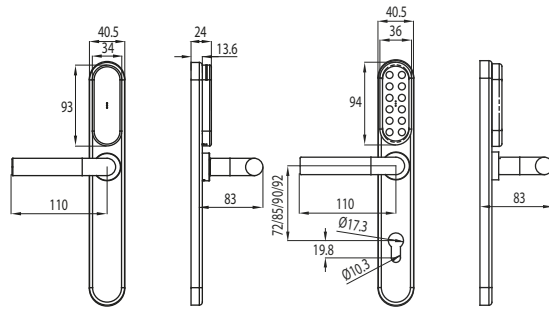

Ext. Escutcheon (LS1)

Ext. Escutcheon with keypad (L2V/L3V)

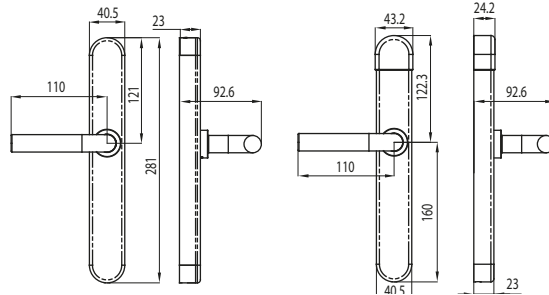

Int. Escutcheon without Openow (L1S)

Int. Escutcheon with Openow (L1S)

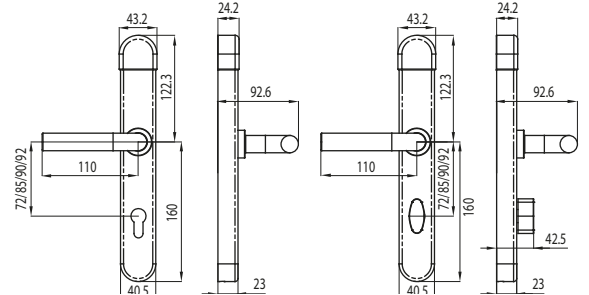

Int. Escutcheon with mech. cylinder and Openow (L3V)

Int. Escutcheon with privacy and Openow (L5S/L8V)

Mechanical Technical Characteristics

External escutcheon

- Not handed.
- Freewheeling handle when the door is close.
- Turns 60° up and down (valid for lift & lock mortise locks).

Internal escutcheon

- Panic function. The internal handle always opens the door.
- The electromechanical clutch works with a special split spindle.
- The spindle has different lengths according the door width.
- From 30mm to 110mm door width.

Mortise lock (not included)

- Compatible with any euro profile mortise lock.
- Pass through follower is required.
- Distance between axes from 70mm to 105mm.
- 7mm, 8mm or 9mm spindle.

Handles and finishes



More models available. Please consult.

i-max Models

Euro profile without electronic privacy

With any euro profile mortise lock.

- 7mm, 8mm or 9mm spindle.
- Distance between axes from 70mm to 105mm.
- L1S Model. Without mechanical key override (blind).
- L2V/L2O Model. With half mechanical key override (visible/hidden).
- L3V/L3O Model. With double mechanical key override (visible/hidden).

Euro profile with electronic privacy

With any euro profile mortise lock.

- 7mm, 8mm or 9mm spindle.
- Distance between axes from 70mm to 105mm.
- L5S Model. Without mechanical key override.
- L8V Model. With visible mechanical key override.
- L8O Model. With hidden mechanical key override.

Euro profile with electronic and mechanic privacy

This model requires a special mortise lock and cylinder from TESA.

- 8mm spindle.
- 85mm distance between axes.
- L5S Model. Without mechanical key override.
- L8V Model. With visible mechanical key override.
- L8O Model. With hidden mechanical key override.

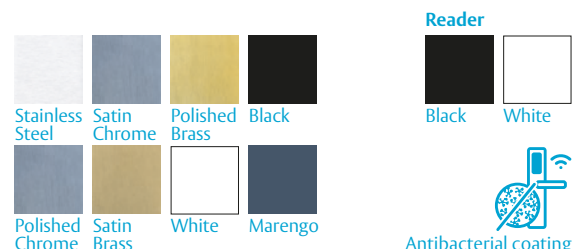

The ASSA ABLOY Group is the global leader in access solutions. Every day, we help billions of people experience a more open world.

ASSA ABLOY Opening Solutions leads the development within door openings and products for access solutions in homes, businesses and institutions. Our offering includes doors, door and window hardware, locks, access control and service.

MAUER
ASSA ABLOY

Mauer Nederland BV
Spaceshuttle 23
3824 ML Amersfoort
Nederland
Tel: 00 31 (0)33 455 0900
www.mauerlocks.com
sales@mauerlocks.com